







36 060 845

- cover plate 78 x 78 mm



| | | |
|---|-----------------------|---------------|
|  | Chrome | 36 060 845-00 |
|  | Brushed Platinum | 36 060 845-06 |
|  | Dark Chrome | 36 060 845-19 |
|  | Matte Black | 36 060 845-33 |
|  | Brushed Chrome | 36 060 845-93 |
|  | Brushed Dark Platinum | 36 060 845-99 |

Required miscellaneous



Concealed wall-mounted single-lever mixer - 35 860 970 90

- max. recess depth 95 mm
- min. recess depth 80 mm



LISSÉ Concealed single-lever mixer with cover plate - Chrome

LISSÉ

36 060 845

Certificates

LGA_29905.

36 060 845

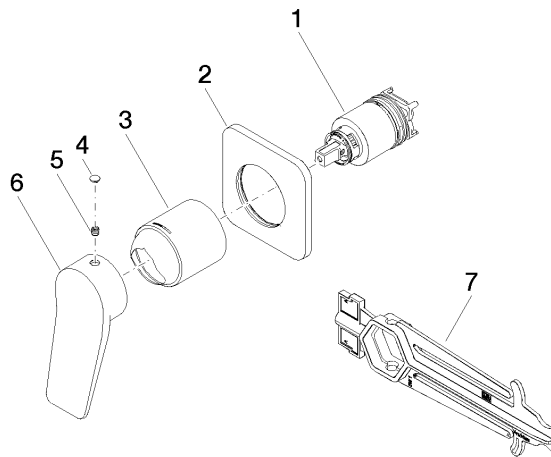

Spare parts list

| No. | Item Number | Name | Quantity used | Delivery time |
|-----|--------------------|-----------|---------------|---------------|
| 1 | 90 15 05 046 02 90 | cartridge | 1 | 2 |
| 2 | 90 27 84 020 00-00 | rosette | 1 | 10 |
| 3 | 09 11 02 288-00 | cover | 1 | 10 |
| 4 | 90 31 20 087 00-00 | plug | 1 | 10 |
| 5 | 90 31 11 030 00 90 | pin | 1 | 2 |
| 6 | 09 20 84 021-00 | handle | 1 | 10 |
| 7 | 90 30 09 064 00 90 | key | 1 | 2 |